

Glass 75

Josep Lluís Xuclà

Lámpara de pie de diseño, fabricada con tubo de cristal estriado de 75 cm de longitud, que permite crear un elemento luminoso flotante para vestir cualquier espacio de un modo imponente y elegante.

Design floor lamp, made of 75 cm long fluted glass tube that allows creating a floating luminous element to dress any space in an imposing and elegant way.



Glass 75 1250

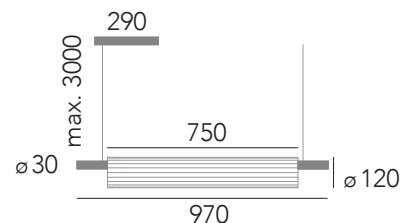

Luz / light

LED 12W 932 lm
200/240V 50/60Hz 2700K/3000K/4000K

Acabados / Finishes

Negro / Black
Custom RAL



1250

Glass 75



Lámpara de pie de diseño, fabricada con tubo de cristal estriado de 75 cm de longitud que permite crear un elemento luminoso flotante para vestir cualquier espacio de un modo imponente y elegante.

Design floor lamp, made of 75 cm long fluted glass tube that allows creating a floating luminous element to dress any space in an imposing and elegant way.

Código / Code	1250
Acabados / Finishes	03 Negro / Black 00 Custom RAL
Luz / Light	30 LED 12W 932 lm 200/240V 50/60Hz 2700K/3000K/4000K
Diseñador / Designer	Josep Lluís Xuclà
Año / Year	2021
Peso / Weight	6 kg
Potencia máx. / Max Power	17W
Material	Hierro / Iron
Alimentación LED / LED tension	200/240V 50/60Hz
Regulación / Dimmable	DALI / Push
CRI	90
Dimensiones embalaje / Box Dimensions	20x20x100cm

Instalación / Installation

Fijar el florón al techo mediante tornillos. Anclar los suspendores al techo, insertar los sensores, nivelar el colgante y cortar el sobrante. Realizar las conexiones eléctricas, comprobar el correcto funcionamiento de la luminaria y cerrar el florón.

Fasten the canopy to the ceiling using screws. Anchor the hangers to the ceiling, insert the wires, level the lamp and cut off the excess. Make the electrical connections, check the correct operation of the luminaire and close the canopy.

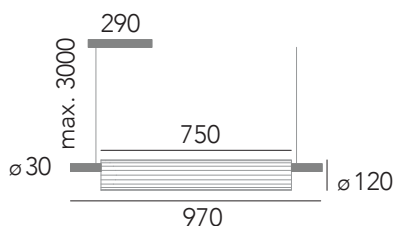

Fabricado según normativa EN60598-1 y regulaciones pertinentes. / Manufactured according EN60598-1 normative and relevant regulations.

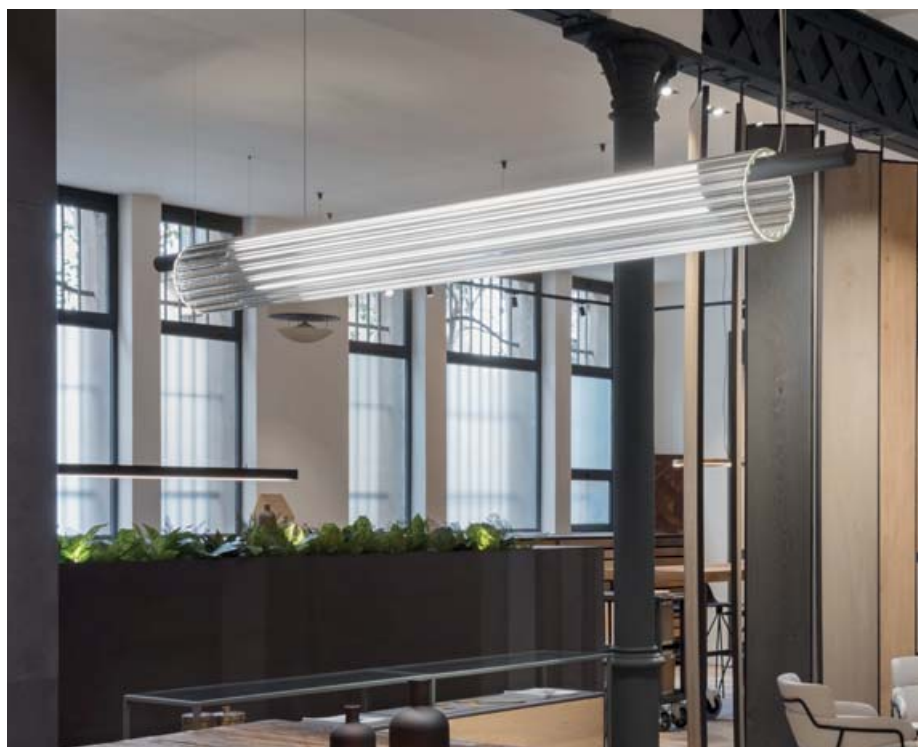

Glass 75

Josep Lluís Xuclà

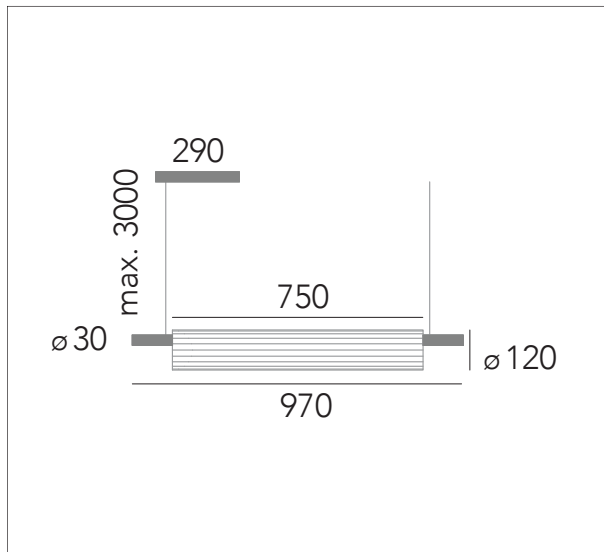

INSOLIT

c/ Cerignola, 13
08022 Barcelona
+34 932 507 640
insolit@insolitbcn.com
insolitbcn.com

Glass 75

Josep Lluís Xuclà



1250XX03

Instrucciones de montaje
Installation instructions

INSOLIT

Instalación y conexión / Installation and Connection

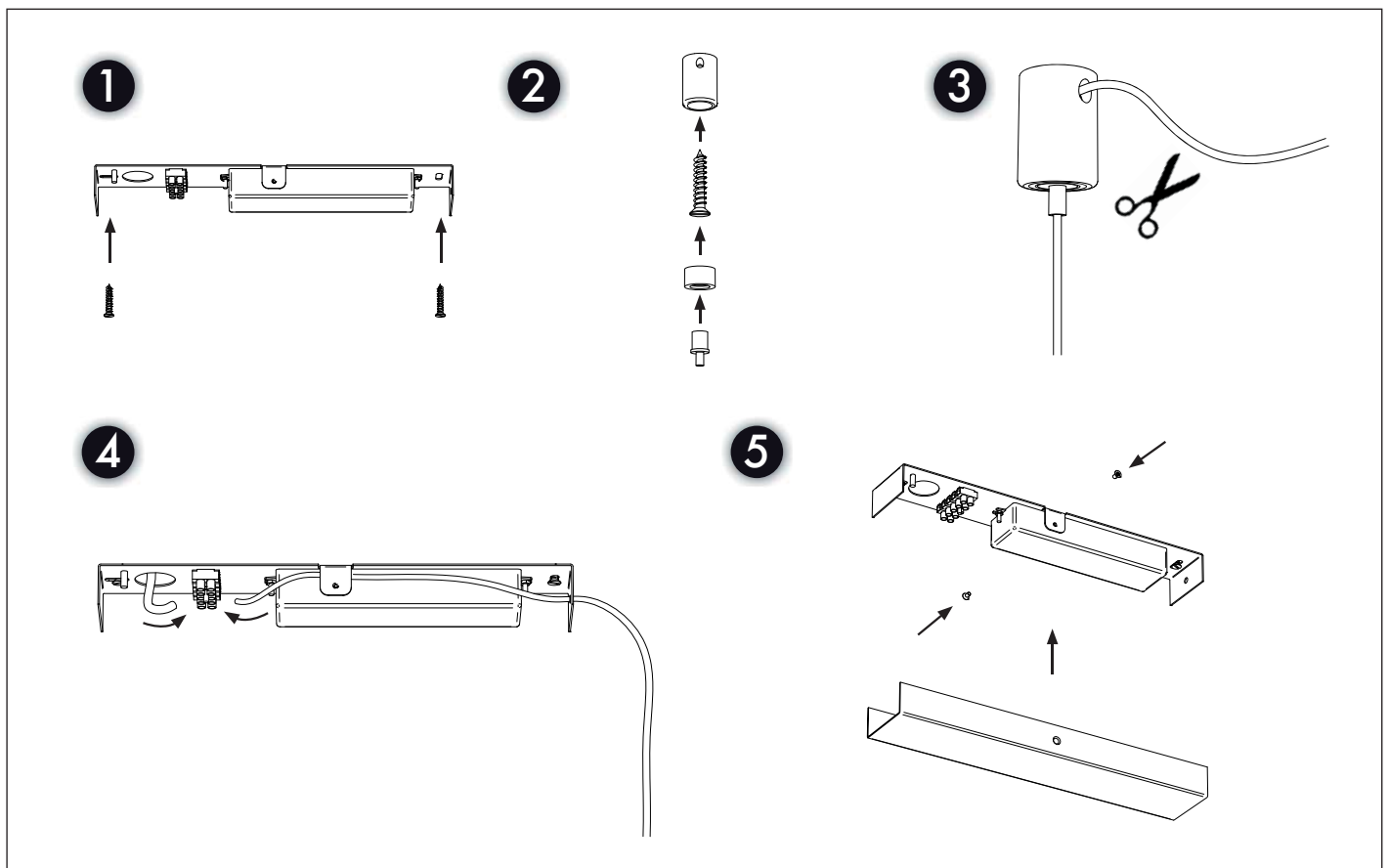

Glass 120

Josep Lluís Xuclà

Lámpara de pie de diseño, fabricada con tubo de cristal estriado de 120 cm de longitud, que permite crear un elemento luminoso flotante para vestir cualquier espacio de un modo imponente y elegante.

Design floor lamp, made of 120 cm long fluted glass tube that allows creating a floating luminous element to dress any space in an imposing and elegant way.



Glass 120 1251

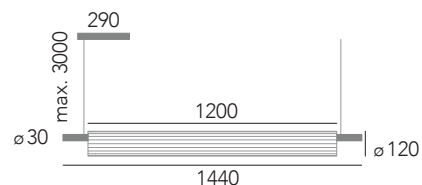

Luz / light

LED 18W 1485 lm
200/240V 50/60Hz 2700K/3000K/4000K

Acabados / Finishes

Negro / Black
Custom RAL



INSOLIT

c/ Cerignola 13, 08022 Barcelona
+34 932 507 640 • insolit@insolitbcn.com • insolitbcn.com



Lámpara de pie de diseño, fabricada con tubo de cristal estriado de 120 cm de longitud que permite crear un elemento luminoso flotante para vestir cualquier espacio de un modo imponente y elegante.

Design floor lamp, made of 120 cm long fluted glass tube that allows creating a floating luminous element to dress any space in an imposing and elegant way.

Código / Code	1251
Acabados / Finishes	03 Negro / Black 00 Custom RAL
Luz / Light	30 LED 18W 1485 lm 200/240V 50/60Hz 2700K/3000K/4000K
Diseñador / Designer	Josep Lluís Xuclà
Año / Year	2021
Peso / Weight	9 kg
Potencia máx. / Max Power	25W
Material	Hierro / Iron
Alimentación LED / LED tension	200/240V 50/60Hz
Regulación / Dimmable	DALI / Push
CRI	90
Dimensiones embalaje / Box Dimensions	20x20x150cm

Instalación / Installation

Fijar el florón al techo mediante tornillos. Anclar los suspendores al techo, insertar los tensores, nivelar el colgante y cortar el sobrante. Realizar las conexiones eléctricas, comprobar el correcto funcionamiento de la luminaria y cerrar el florón.

Fasten the canopy to the ceiling using screws. Anchor the hangers to the ceiling, insert the wires, level the lamp and cut off the excess. Make the electrical connections, check the correct operation of the luminaire and close the canopy.

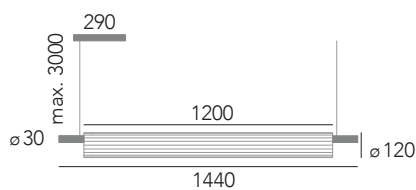

Fabricado según normativa EN60598-1 y regulaciones pertinentes. / Manufactured according EN60598-1 normative and relevant regulations.

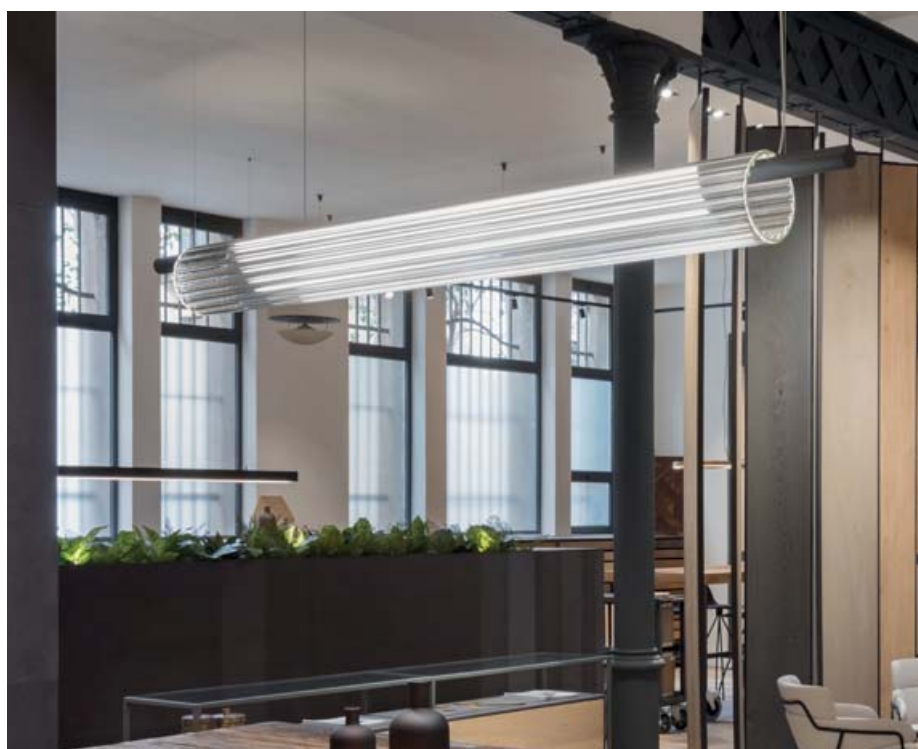

Glass 120

Josep Lluís Xuclà

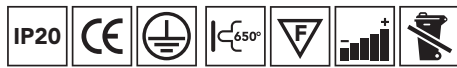
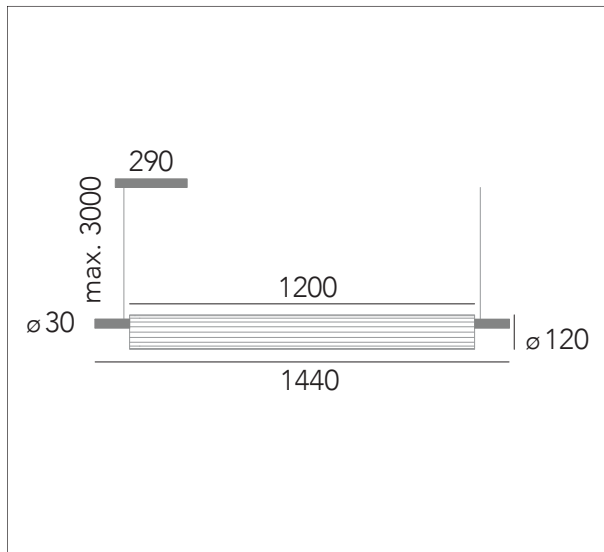

INSOLIT

c/ Cerignola, 13
08022 Barcelona
+34 932 507 640
insolit@insolitbcn.com
insolitbcn.com

Glass 120

Josep Lluís Xuclà



1251XX03

Instrucciones de montaje
Installation instructions

INSOLIT

Instalación y conexión / Installation and Connection

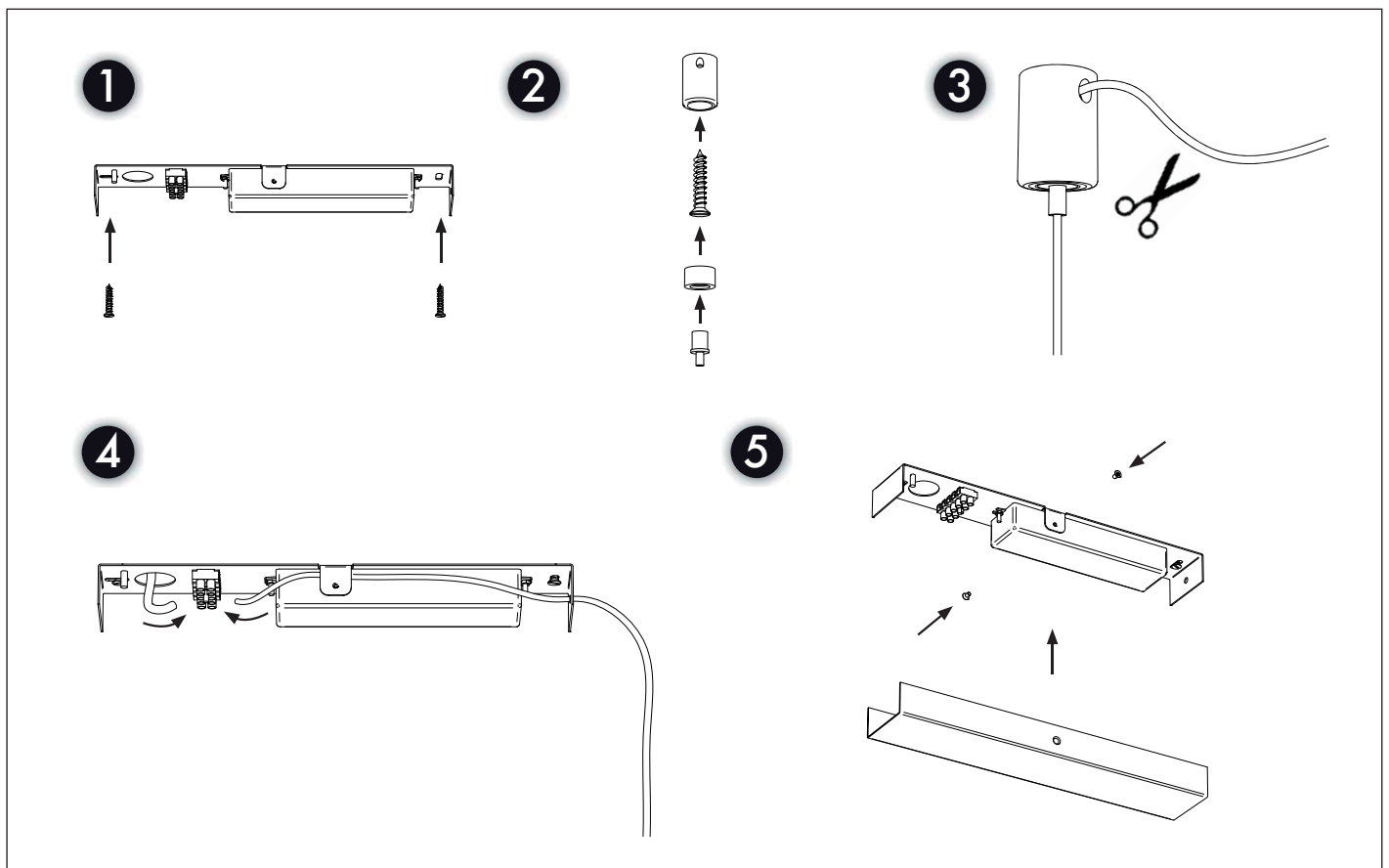

Glass 150

Josep Lluís Xuclà

Lámpara de pie de diseño, fabricada con tubo de cristal estriado de 150 cm de longitud, que permite crear un elemento luminoso flotante para vestir cualquier espacio de un modo imponente y elegante.

Design floor lamp, made of 150 cm long fluted glass tube that allows creating a floating luminous element to dress any space in an imposing and elegant way.



Glass 150 1252

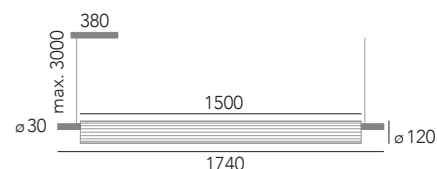

Luz / light

LED 24W 1980 lm
200/240V 50/60Hz 2700K/3000K/4000K

Acabados / Finishes

Negro / Black
Custom RAL

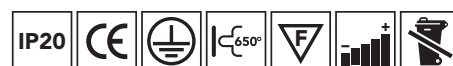

INSOLIT

c/ Cerignola 13, 08022 Barcelona
+34 932 507 640 • insolit@insolitbcn.com • insolitbcn.com



Lámpara de pie de diseño, fabricada con tubo de cristal estriado de 150 cm de longitud que permite crear un elemento luminoso flotante para vestir cualquier espacio de un modo imponente y elegante.

Design floor lamp, made of 150 cm long fluted glass tube that allows creating a floating luminous element to dress any space in an imposing and elegant way.

Código / Code	1252
Acabados / Finishes	03 Negro / Black 00 Custom RAL
Luz / Light	30 LED 24W 1980 lm 200/240V 50/60Hz 2700K/3000K/4000K
Diseñador / Designer	Josep Lluís Xuclà
Año / Year	2021
Peso / Weight	11,2 kg
Potencia máx. / Max Power	34W
Material	Hierro / Iron
Alimentación LED / LED tension	200/240V 50/60Hz
Regulación / Dimmable	DALI / Push
CRI	90
Dimensiones embalaje / Box Dimensions	20x20x200cm

Instalación / Installation

Fijar el florón al techo mediante tornillos. Anclar los suspensores al techo, insertar los tensores, nivelar el colgante y cortar el sobrante. Realizar las conexiones eléctricas, comprobar el correcto funcionamiento de la luminaria y cerrar el florón.

Fasten the canopy to the ceiling using screws. Anchor the hangers to the ceiling, insert the wires, level the lamp and cut off the excess. Make the electrical connections, check the correct operation of the luminaire and close the canopy.

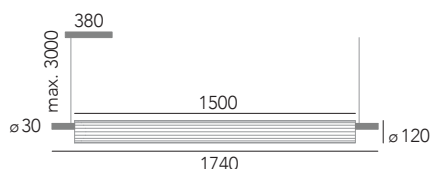

Fabricado según normativa EN60598-1 y regulaciones pertinentes. / Manufactured according EN60598-1 normative and relevant regulations.

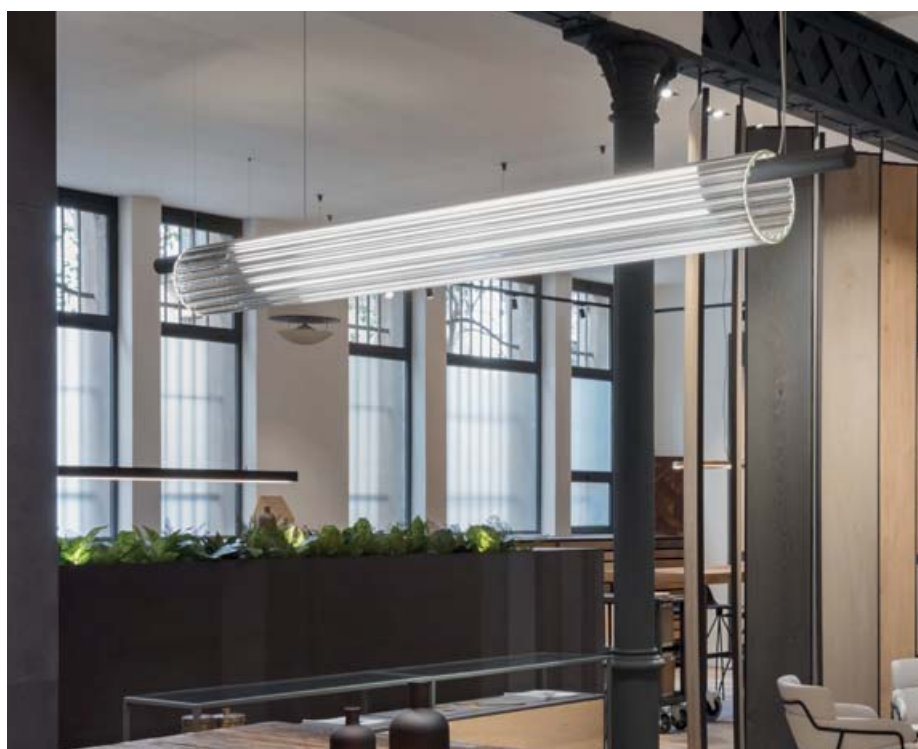

Glass 150

Josep Lluís Xuclà

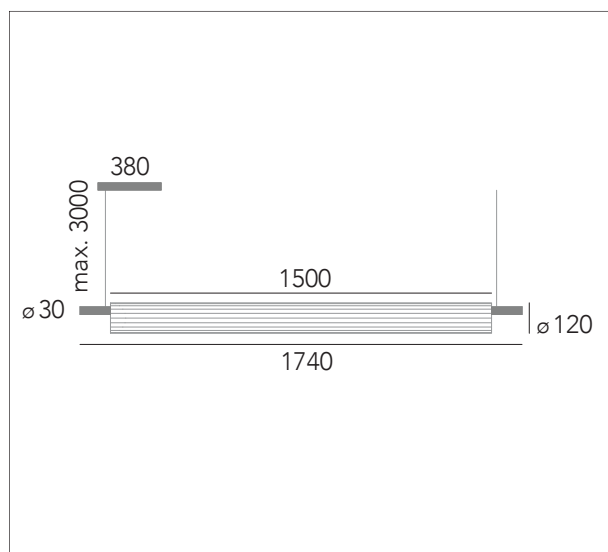

INSOLIT

c/ Cerignola, 13
08022 Barcelona
+34 932 507 640
insolit@insolitbcn.com
insolitbcn.com

Glass 150

Josep Lluís Xuclà



1252XX03

Instrucciones de montaje

Installation instructions

INSOLIT

Instalación y conexión / Installation and Connection

