

Focus Line Magnet

J. M. Wilmotte

Proyector en aluminio mecanizado con base magnética para instalación móvil sobre superficies de metal. Acabados en negro anodizado mate y en blanco o champagne lacado, con anillo frontal y tapa posterior en negro anodizado mate. Se suministra sin cable.

Machined aluminum spotlight with magnetic base for mobile installation on metallic surfaces. Available in matte anodized black and lacquered white or champagne finishes, with front ring and back cover finished in anodized black. Provided without cord connection.



1033 - Focus Line Magnet

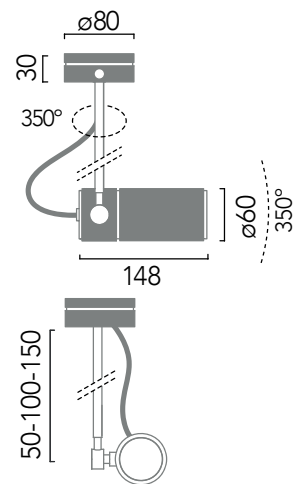

Luz / light

GU10 LED Ø50 10W máx.

110/240V 50/60Hz

Bombilla no incluida / Bulb not included

Colores / Colors

Blanco / White

Negro / Black

Champagne

Custom RAL

Tija / Stem

5 cm

10 cm

15 cm



Magnet

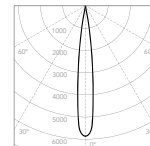

Curvas fotométricas en /
Photometric Curves on www.insolitbcn.com

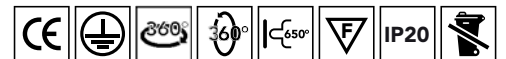

INSOLIT

1033

Focus Line Magnet



Proyector en aluminio mecanizado con base magnética para instalación móvil sobre superficies de metal. Acabados en negro anodizado mate y en blanco o champagne lacado, con anillo frontal y tapa posterior en negro anodizado mate. Se suministra sin cable.

Machined aluminum spotlight with magnetic base for mobile installation on metallic surfaces. Available in matte anodized black and lacquered white or champagne finishes, with front ring and back cover finished in anodized black. Provided without cord connection.

Código / Code	1033
Colores / Colors	01 Blanco / White 03 Negro / Black 04 Champagne 00 Custom RAL (Consult)
Luz / Light	01 GU10 LED Ø50 10W máx. 110/240V 50/60Hz Bombilla no incluida / Bulb not included
Portalamparas / Lampholder	GU10
Potencia máx. / Max Power	LED 10W
Material	Aluminio / Aluminium
Diseñador / Designer	J. M. Wilmotte
Año / Year	2017
Peso / Weight	3,25 Kg
Dimensiones embalaje / Box Dimensions	38x22x11cm

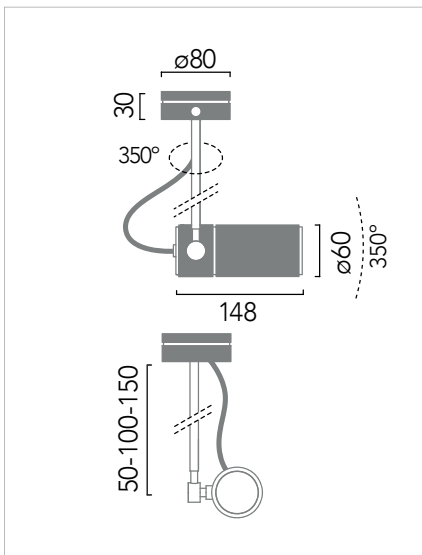

Magnet

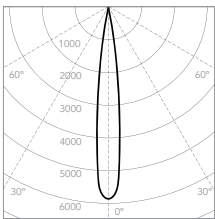

Fotometrías completas disponibles en / Full photometrics on: www.insolitbcn.com

Fabricado según normativa EN60598-1 y regulaciones pertinentes. / Manufactured according EN60598-1 normative and relevant regulations.

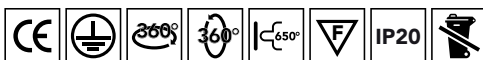

INSOLIT

Insolit BCN lighting
C/Mallorca 305, 08037 Barcelona
+34 932 507 640
insolit@insolitbcn.com
www.insolitbcn.com

Focus Line Magnet

J.M.WILMOTTE

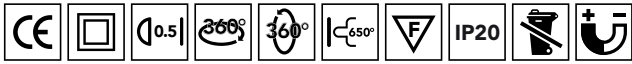
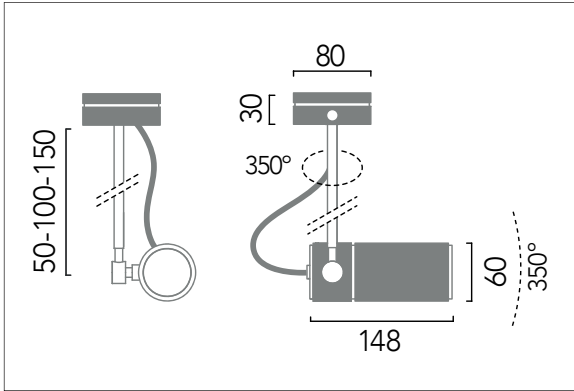

INSOLIT

Insolit
c/Cerignola, 13
08022 Barcelona
+34 932 507 640
insolit@insolitbcn.com
insolitbcn.com

Focus Line Magnet

J.M.WILMOTTE



1033XX03

Instrucciones de montaje

Installation instructions

INSOLIT

Cambio de la lámpara / Lamp Replacement

